

CB1567

DIMENSIONS ARE $\frac{\text{INCHES}}{\text{MILLIMETERS}}$

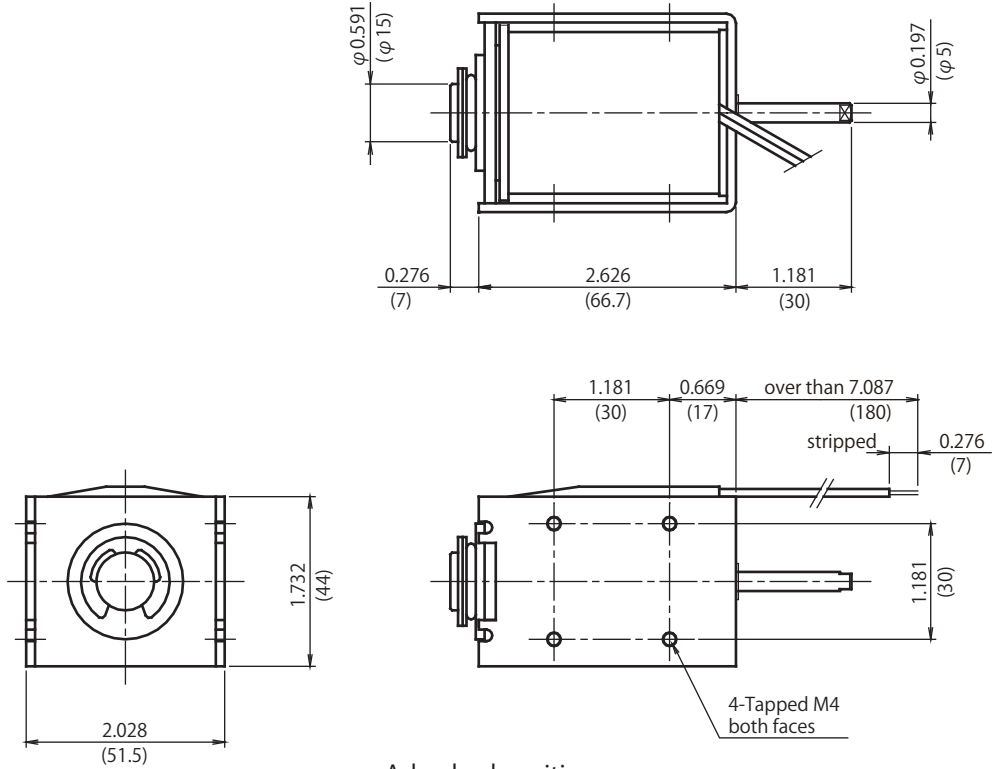

Adsorbed position

Duty Cycle

Insulation Class A 105°C(221°F)

Part Number	Coil	Rated	Rated	Rated
	Resistance	DC6V	DC12V	DC24V
CB15670033	3.3 Ohms	100%	25%	6%
CB15670050	5 Ohms	-	40%	10%
CB15670130	13 Ohms	-	100%	25%
CB15670260	26 Ohms	-	-	50%
CB15670520	52 Ohms	-	-	100%

Graph Force - Stroke

DC24V 20°C(68°F)

