

CB0830

DIMENSIONS ARE $\frac{\text{INCHES}}{\text{MILLIMETERS}}$

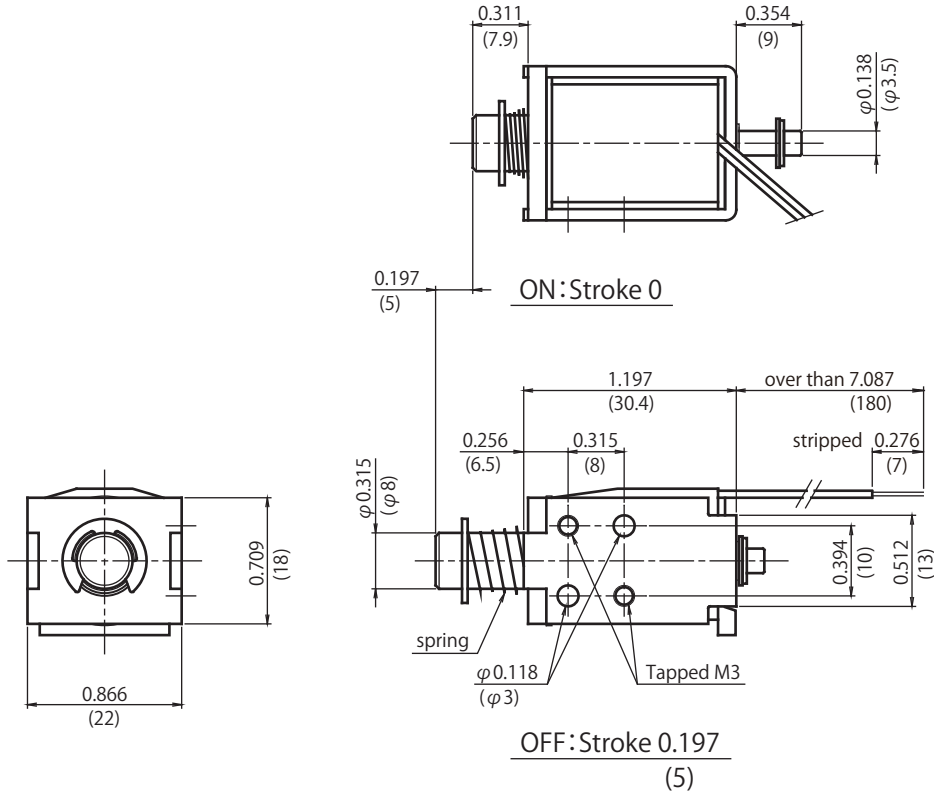

Duty Cycle

Insulation Class A 105°C(221°F)

Part Number	Coil	Rated	Rated	Rated
	Resistance	DC6V	DC12V	DC24V
CB08300120	12 Ohms	100%	25%	6%
CB08300190	19 Ohms	-	40%	10%
CB08300480	48 Ohms	-	100%	25%
CB08300960	96 Ohms	-	-	50%
CB08301920	192 Ohms	-	-	100%

Graph Force - Stroke

DC24V 20°C(68°F)

*force is a value which attached a return spring.

