

CA1662

DIMENSIONS ARE $\frac{\text{INCHES}}{\text{MILLIMETERS}}$

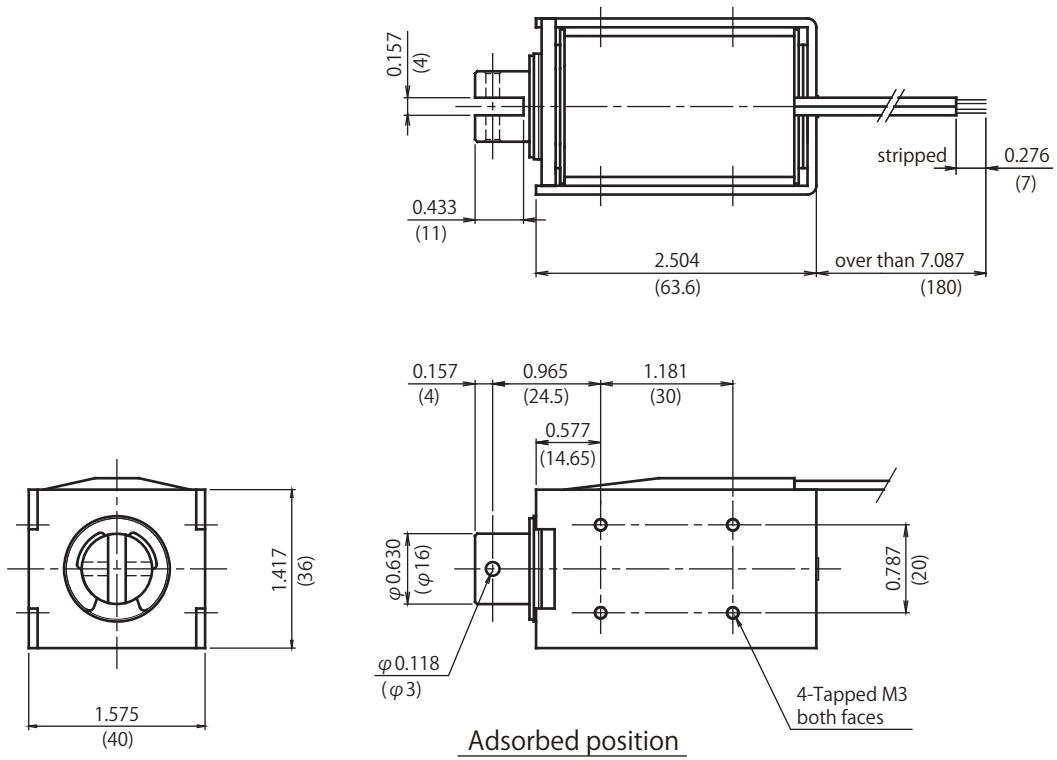

Duty Cycle

Insulation Class A 105°C(221°F)

Part Number	Coil	Rated	Rated	Rated
	Resistance	DC6V	DC12V	DC24V
CA16620040	4 Ohms	100%	25%	6%
CA16620060	6 Ohms	-	40%	10%
CA16620160	16 Ohms	-	100%	25%
CA16620320	32 Ohms	-	-	50%
CA16620640	64 Ohms	-	-	100%

Graph Force - Stroke

DC24V 20°C(68°F)

