

# CA1029

DIMENSIONS ARE  $\frac{\text{INCHES}}{\text{MILLIMETERS}}$

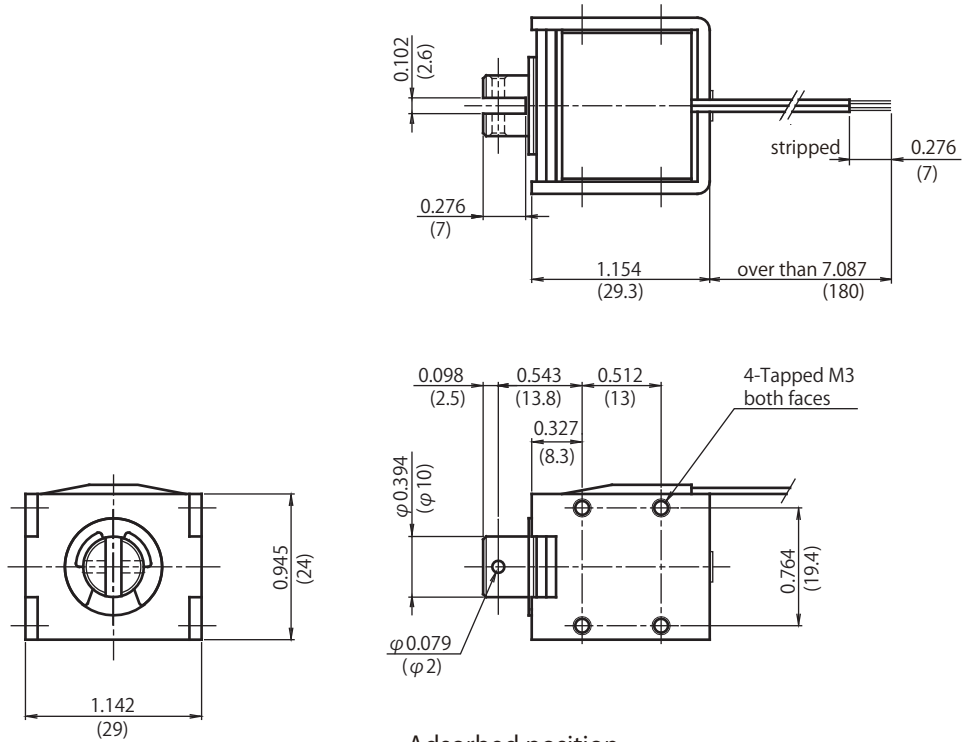

Adsorbed position

## Duty Cycle

Insulation Class A 105°C(221°F)

Part Number	Coil	Rated	Rated	Rated
	Resistance	DC6V	DC12V	DC24V
CA10290100	10 Ohms	100%	25%	6%
CA10290170	17 Ohms	-	40%	10%
CA10290410	41 Ohms	-	100%	25%
CA10290820	82 Ohms	-	-	50%
CA10291640	164 Ohms	-	-	100%

## Graph Force - Stroke

DC24V 20°C(68°F)

