

CA0730

DIMENSIONS ARE $\frac{\text{INCHES}}{\text{MILLIMETERS}}$

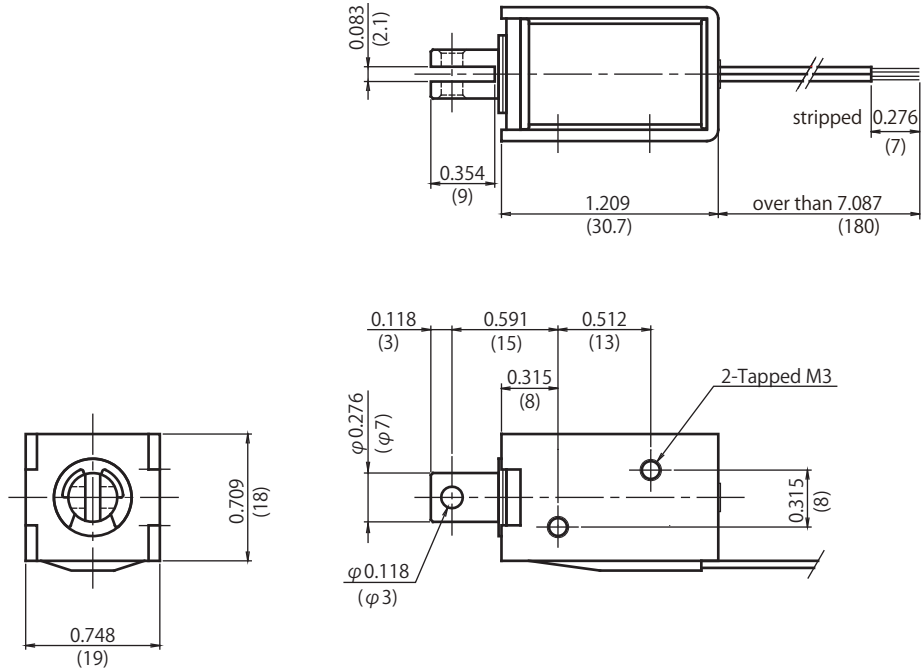

Adsorbed position

Duty Cycle

Insulation Class A 105°C(221°F)

Part Number	Coil	Rated	Rated	Rated
	Resistance	DC6V	DC12V	DC24V
CA07300160	16 Ohms	100%	25%	6%
CA07300260	26 Ohms	-	40%	10%
CA07300660	66 Ohms	-	100%	25%
CA07301300	130 Ohms	-	-	50%
CA07302600	260 Ohms	-	-	100%

Graph Force - Stroke

DC24V 20°C(68°F)

