

# CA0837

DIMENSIONS ARE  $\frac{\text{INCHES}}{\text{MILLIMETERS}}$

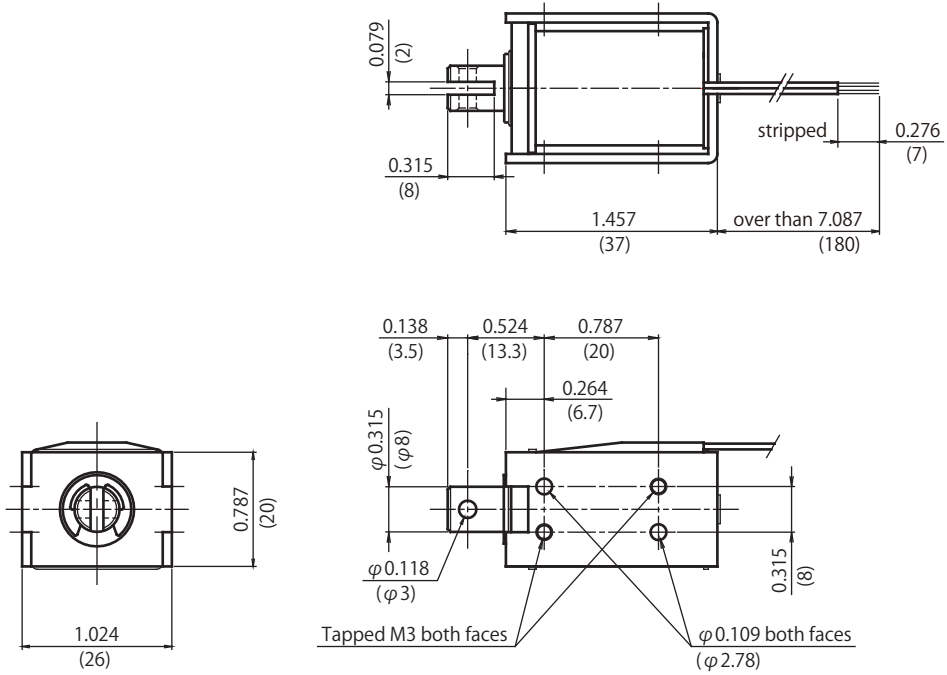

Adsorbed position

## Duty Cycle

Insulation Class A 105°C(221°F)

Part Number	Coil	Rated	Rated	Rated
	Resistance	DC6V	DC12V	DC24V
CA08370090	9 Ohms	100%	25%	6%
CA08370140	14 Ohms	-	40%	10%
CA08370360	36 Ohms	-	100%	25%
CA08370720	72 Ohms	-	-	50%
CA08371440	144 Ohms	-	-	100%

## Graph Force - Stroke

DC24V 20°C(68°F)

